

PROFILES

ALFA

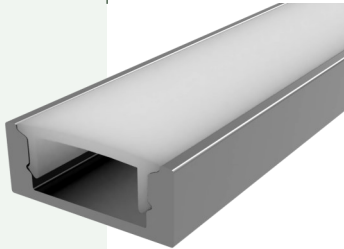

max 15 W/m
7,4 x 17,5 x 2000 mm

BETA

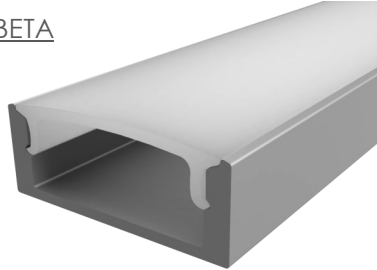

max 20 W/m
9,2 x 22,6 x 2000 mm

- . Anodised aluminium
- . Frosted cover
- . Endcaps and clips available

BETA

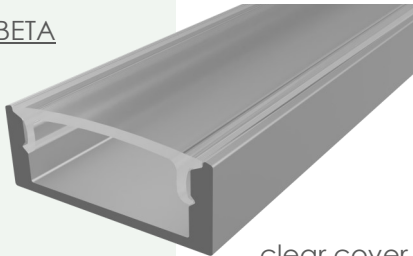

clear cover
max 20 W/m
9,2 x 22,6 x 2000 mm

DELTA

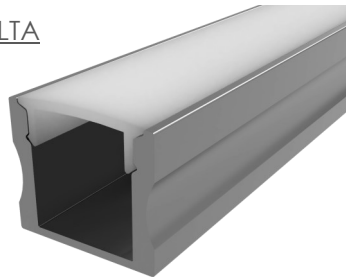

max 20 W/m
15,3 x 17,1 x 2000 mm

EPSILON

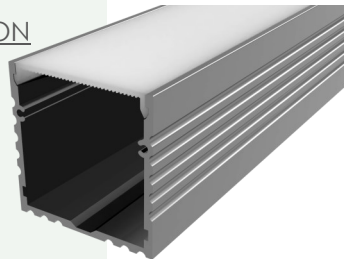

max 35 W/m
35 x 35 x 2000 mm

IOTA

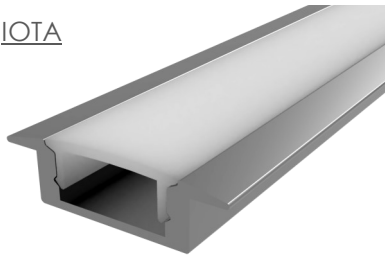

max 15 W/m
7,4 x 24,8 x 2000 mm

KAPPA

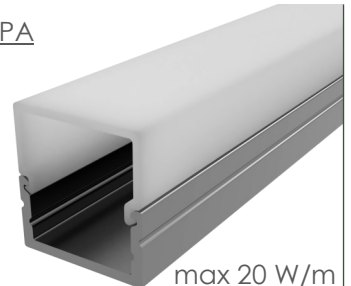

max 20 W/m
20,7 x 19,5 x 2000 mm

LAMBDA

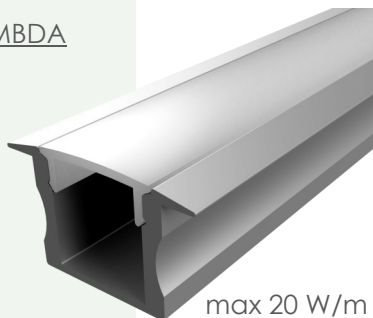

max 20 W/m
15,3 x 24,8 x 2000 mm

PHI

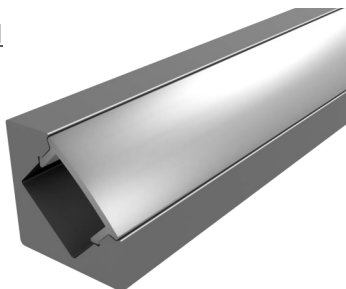

max 20 W/m
18,6 x 18,6 x 2000 mm

SIGMA

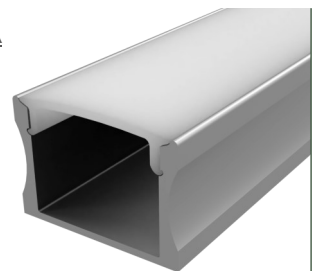

max 20 W/m
16,2 x 22,6 x 2000 mm