

PIATTO

EE-PO3-12/200

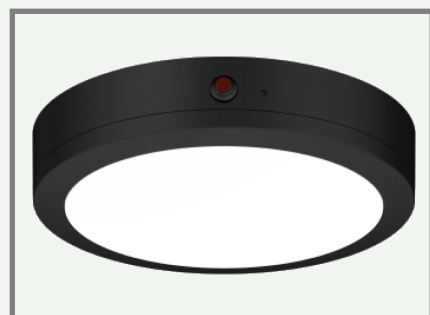

12W

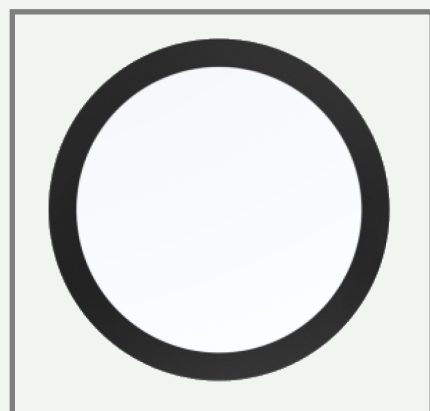

3000/
4000K



1080 lm



110°



Optional
dimmable

TECHNICAL FEATURES

Power	12 W
Input current	AC 230V
IP rating	IP65
IK rating	IK10
Dimmable	Optional Triac
Versions	Standard Adjustable sensor Emergency unit Adj. Sensor + Em. unit

LIGHTING CHARACTERISTICS

Light color	3000/4000K
Beam angle	110°
CRI	RA80
Lumen output	1080 lm
LEDtype	SMD
Lifetime	L70B50 50000h
SDCM	<6

MEASUREMENTS AND MATERIAL FEATURES

Measurements	200 x 60 mm
Material	Polycarbonate housing Polycarbonate diffuser
Color	White/black

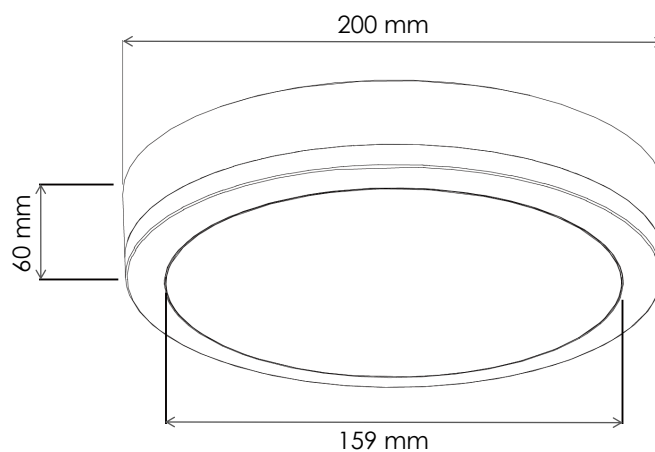

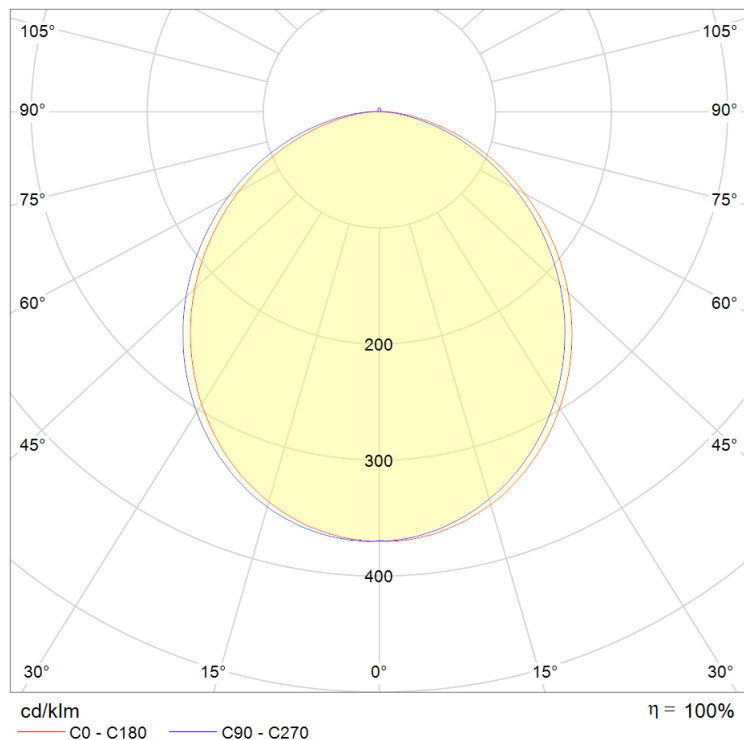

P03-12/200

PRODUCTTYPE	POWER	DIAMETER	COLOR	LIGHT COLOR	OPTIONAL
EE- P03 -	12	/ 200	B	/ 30	S
PLAFFONIER	12 W	200 MM	BLACK	KELVIN	S = SENSOR E = EMERGENCY UNIT SE = SENSOR + EM. UNIT

EE-P03-12/200B/30	12W, 200cm, Black, 3000K
EE-P03-12/200B/30S	12W, 200cm, Black, 3000K, sensor
EE-P03-12/200B/30E	12W, 200cm, Black, 3000K, em.unit
EE-P03-12/200B/30SE	12W, 200cm, Black, 3000K, sensor+em.unit
EE-P03-12/200W/30	12W, 200cm, White, 3000K
EE-P03-12/200W/30S	12W, 200cm, White, 3000K, sensor
EE-P03-12/200W/30E	12W, 200cm, White, 3000K, em.unit
EE-P03-12/200W/30SE	12W, 200cm, White, 3000K, sensor+em.unit
EE-P03-12/200B/40	12W, 200cm, Black, 4000K
EE-P03-12/200B/40S	12W, 200cm, Black, 4000K, sensor
EE-P03-12/200B/40E	12W, 200cm, Black, 4000K, em.unit
EE-P03-12/200B/40SE	12W, 200cm, Black, 4000K, sensor+em.unit
EE-P03-12/200W/40	12W, 200cm, White, 4000K
EE-P03-12/200W/40S	12W, 200cm, White, 4000K, sensor
EE-P03-12/200W/40E	12W, 200cm, White, 4000K, em.unit
EE-P03-12/200W/40SE	12W, 200cm, White, 4000K, sensor+em.unit