

Downlight Recessed EE-NDL40

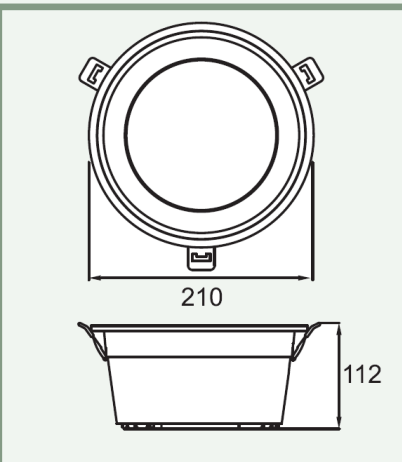

40W



2700/
3000/4000K



115 lm/w



100°



Remote
Led driver

TECHNICAL FEATURES

Power	40W
Input	1050mA-36V
Lumen	4600Lm
Dimmable	Remote Led Driver
IP rating	40
Max. amb. Temp.	45°C

MEASUREMENTS AND MATERIAL FEATURES

Measurements	210 x 112 mm
Material	aluminium
Color outerring	black/white/Grey
Color innerring	Mirror/mat

LIGHTING CHARACTERISTICS

Light color	2700/3000/4000K
Beam angle	100°
Diffuser	High quality PMMA
Cut-out	195 mm
LED type	SMD
Life time	L90B10 50000h
Reflector	Mirror / Mat



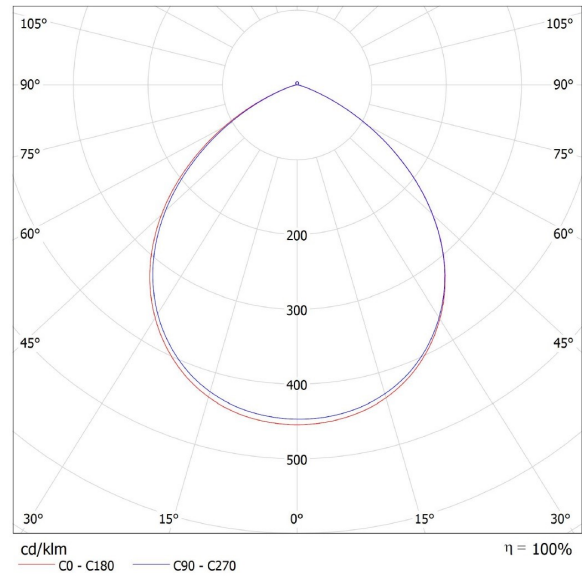

Polar curve

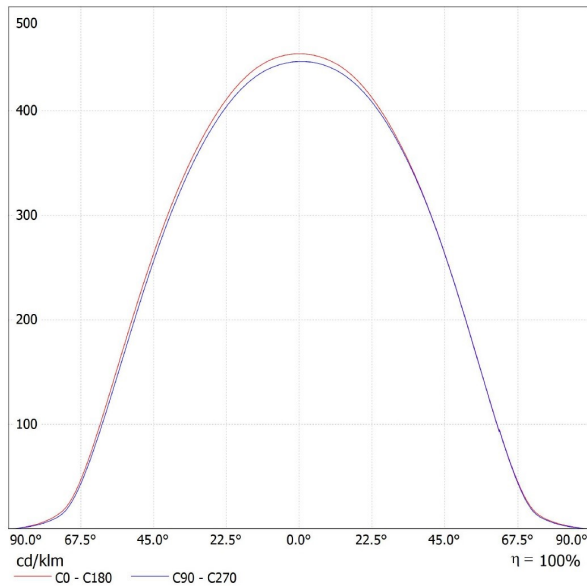

Linear Curve

	PRODUCTTYPE	POWER	LIGHT COLOR	BEAM ANGLE	COLOR OUTERRING	COLOR INNERRING
EE-	NDL	40	2700/3000/4000	100		
	DOWNLIGHT	WATT	KELVIN	°	BLACK/WHITE/ Grey	Mirror/mat