

LEDSTRIP

SILICONE LED NEON LIGHT

EE-NL1023/10

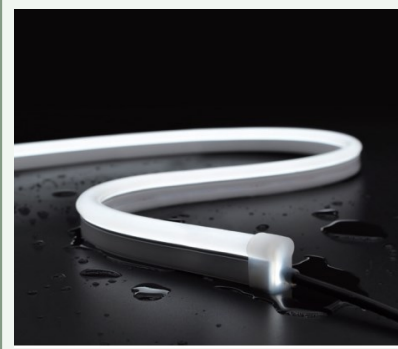

10W/m



2100K - 6000K



387 lm/m
at 4000K



180°

TECHNICAL FEATURES

Power	10W/m
Input current	24 Vdc
IP rating	67
Max. amb. Temp.	-25°C up to 45 °C

LIGHTING CHARACTERISTICS WHITE

Light color	2100/2400/2700/3000/3500 /4000/5000/6000K
Beam angle	180°
CRI	RA90+
Lumen / meter	2100K: 310 lm/m 2400K: 322 lm/m 2700K: 349 lm/m 3000K: 345 lm/m 3500K: 381 lm/m 4000K: 387 lm/m 5000K: 376 lm/m 6000K: 350 lm/m

MEASUREMENTS AND MATERIAL FEATURES

Measurements	10 x 23 x max.run length mm
Cutable every...	50 mm

LIGHTING CHARACTERISTICS COLORS

Light color	Red/Green/Blue/Yellow/ Pink/RGB
Beam angle	180°
CRI	-
SDCM	3
Lumen / meter	
R	148 lm/m
G	404 lm/m
B	74 lm/m
Y	125 lm/m
P	162 lm/m
RGB	145 lm/m at RGB

LIGHTING CHARACTERISTICS TUNABLE WHITE

Light color	Tunable white ww+w 2200 to 6000K
CRI	RA90+
Lumen / meter	TW: 362 lm/m at ww+w

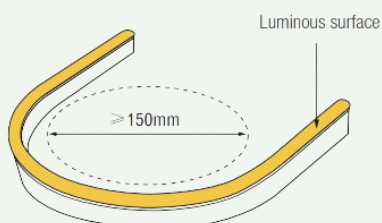
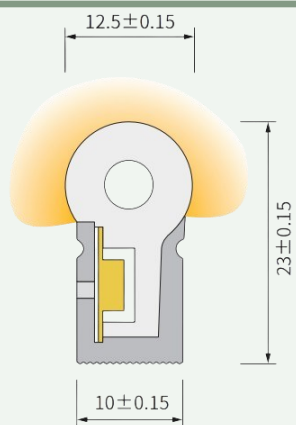

Accessories

<p>Aluminium profile 1000x12.5x15.5mm (L x W x H)</p>	
<p>Mounting Clips 20x12.5x15.5mm (L x W x H)</p>	
<p>End Caps IP67: 2 pin for WHT 3 pin for TW 4 pin for RGB</p>	
<p>Close End cap IP67</p>	

Light color	Unit cut	Max.run length CV	Max.run length CC
2100K	50 mm	5 m	17 m
2400K	50 mm	5 m	17 m
2700K	50 mm	5 m	17 m
3000K	50 mm	5 m	17 m
3500K	50 mm	5 m	17 m
4000K	50 mm	5 m	17 m
5000K	50 mm	5 m	17 m
6000K	50 mm	5 m	17 m
TW	50 mm	5 m	-
R	50 mm	5 m	22 m
G	50 mm	5 m	17 m
B	50 mm	5 m	17 m
Y	50 mm	5 m	22 m
P	50 mm	5 m	17m
RGB	62.5 mm	5 m	-

Dimensions

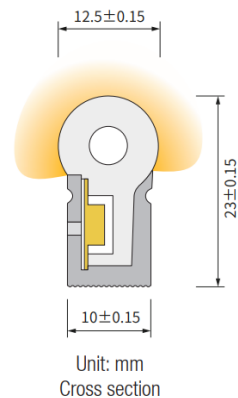
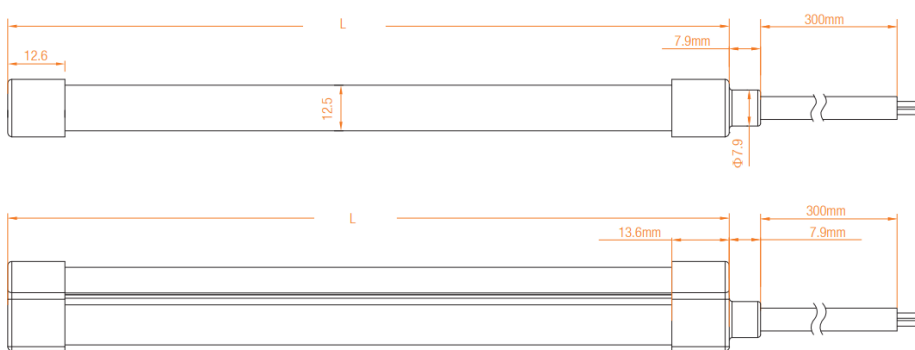

Connection Diagram

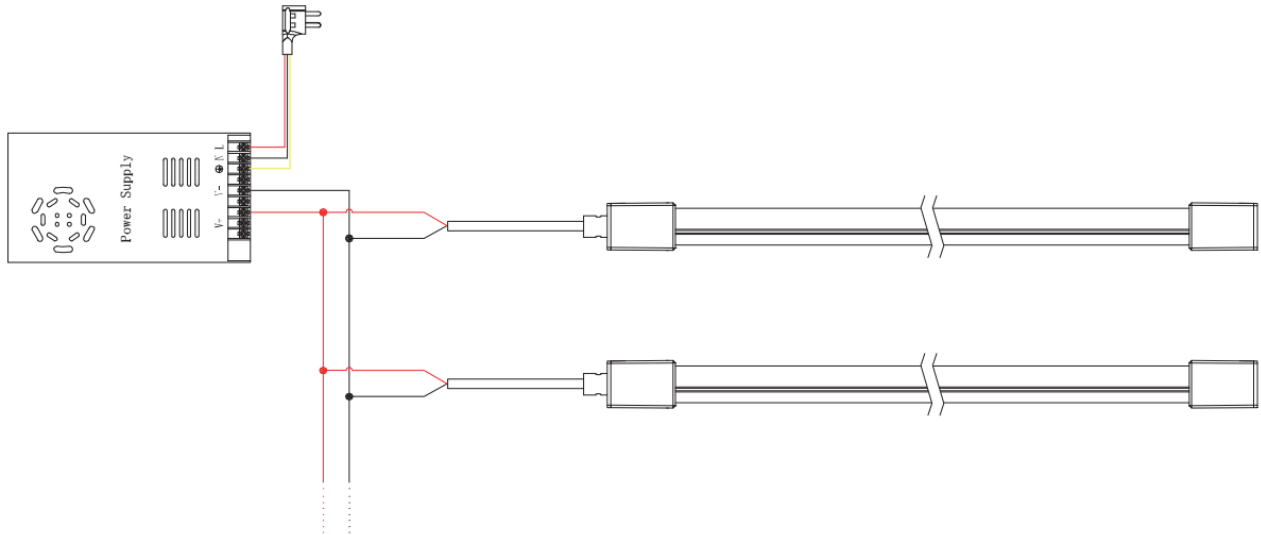

Single Color Connection Diagram

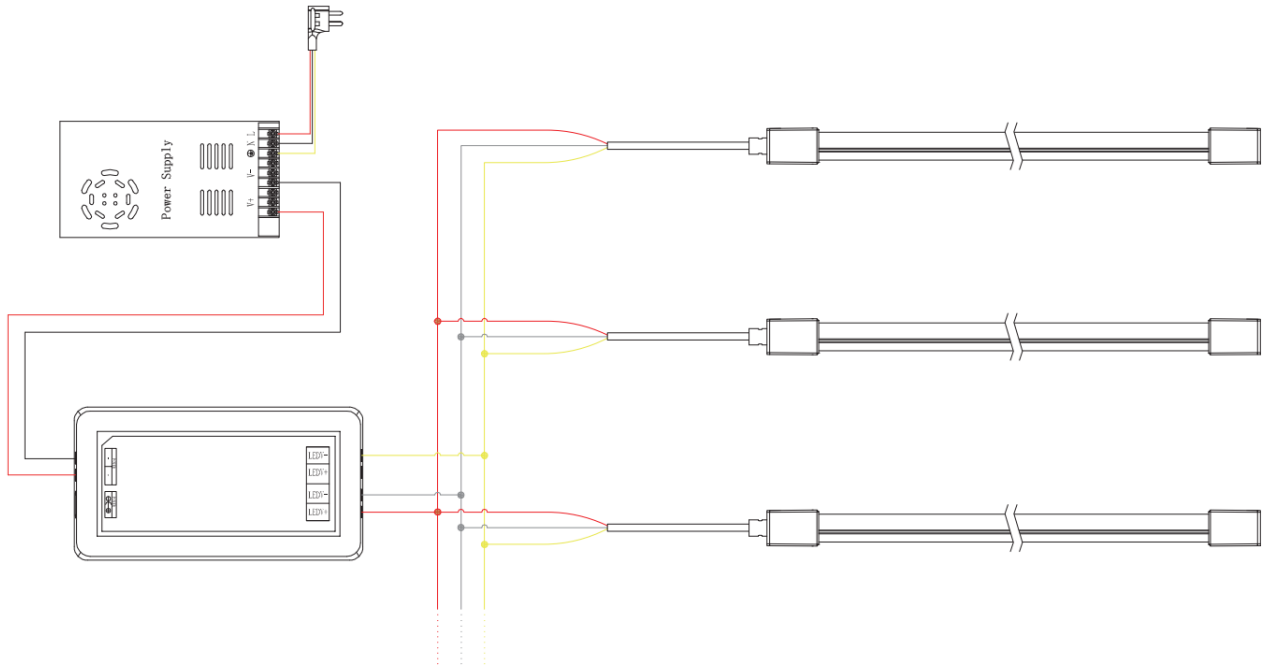

Tunable White Connection Diagram

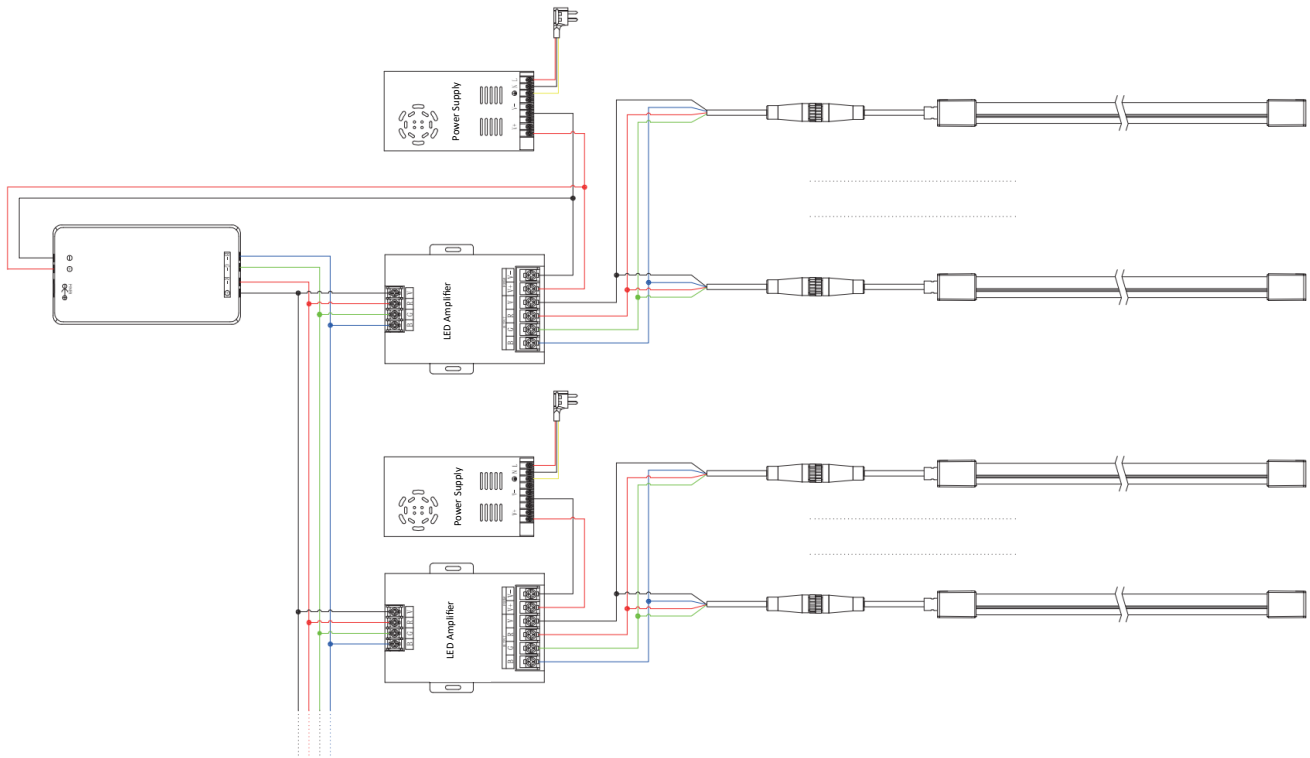

RGB Connection Diagram

PRODUCTTYPE	Dimension	POWER	LIGHT COLOR
EE -NL 1023 / 10 - 24	10x23 mm	WATT/m	2400 KELVIN

SUMMARY PRODUCTCODES LED SELECONE NEON LIGHT 10WATT 10x23 mm

- EE-NL1023/10-21
- EE-NL1023/10-24
- EE-NL1023/10-27
- EE-NL1023/10-30
- EE-NL1023/10-35
- EE-NL1023/10-40
- EE-NL1023/10-50
- EE-NL1023/10-60
- EE-NL1023/10-TW
- EE-NL1023/10-R
- EE-NL1023/10-G
- EE-NL1023/10-B
- EE-NL1023/10-Y
- EE-NL1023/10-P
- EE-NL1023/10-RGB

Accessories CODES FOR LED SELECONE NEON LIGHT 10x23 mm

EE-NLCL/1023

EE-NLAP/1023 -1000

