

LEDSTRIP

SILICONE LED NEON LIGHT

EE-NL1023/15

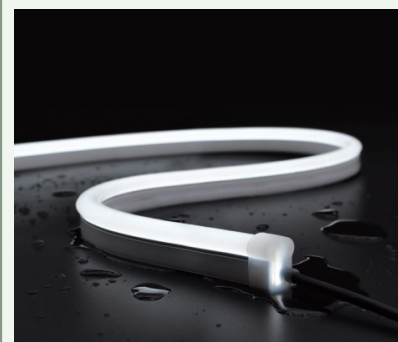

15W/m



2100K - 6000K



542 lm/m
at 4000K



180°

TECHNICAL FEATURES

Power	15W/m
Input current	24 Vdc
IP rating	67
Max. amb. Temp.	-25°C up to 35 °C

LIGHTING CHARACTERISTICS WHITE

Light color	2100/2400/2700/3000/3500 /4000/5000/6000K
Beam angle	180°
CRI	RA90+
Lumen / meter	2100K: 433 lm/m 2400K: 454 lm/m 2700K: 491 lm/m 3000K: 478 lm/m 3500K: 534 lm/m 4000K: 542 lm/m 5000K: 531 lm/m 6000K: 500 lm/m

MEASUREMENTS AND MATERIAL FEATURES

Measurements	10 x 23 x max.run length mm
Cutable every...	50 mm

LIGHTING CHARACTERISTICS COLORS

Light color	Red/Green/Blue/Yellow/ Pink/RGB
Beam angle	180°
CRI	-
SDCM	3
Lumen / meter	
R	197 lm/m
G	513 lm/m
B	103 lm/m
Y	156 lm/m
P	218 lm/m
RGB	181 lm/m at RGB

LIGHTING CHARACTERISTICS TUNABLE WHITE

Light color	Tunable white ww+w 2200 to 6000K
CRI	RA90+
Lumen / meter	TW: 509 lm/m at ww+w

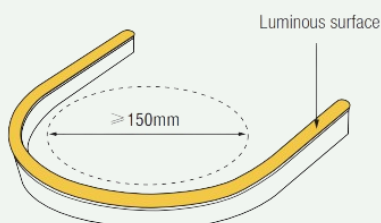
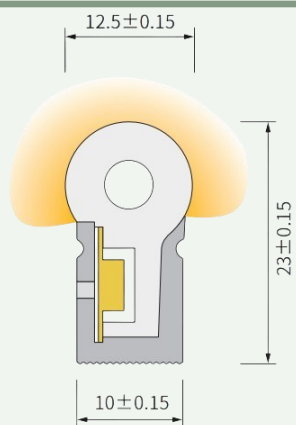

Accessories

<p>Aluminium profile 1000x12.5x15.5mm (L x W x H)</p>	
<p>Mounting Clips 20x12.5x15.5mm (L x W x H)</p>	
<p>End Caps IP67: 2 pin for WHT 3 pin for TW 4 pin for RGB</p>	
<p>Close End cap IP67</p>	

Light color	Unit cut	Max.run length CV	Max.run length CC
2100K	50 mm	5 m	m
2400K	50 mm	5 m	13 m
2700K	50 mm	5 m	13 m
3000K	50 mm	5 m	13 m
3500K	50 mm	5 m	13 m
4000K	50 mm	5 m	13 m
5000K	50 mm	5 m	13 m
6000K	50 mm	5 m	13 m
TW	50 mm	5 m	-
R	50 mm	5 m	17 m
G	50 mm	5 m	13 m
B	50 mm	5 m	13 m
Y	50 mm	5 m	17 m
P	50 mm	5 m	13 m
RGB	62.5 mm	5 m	-

Dimensions

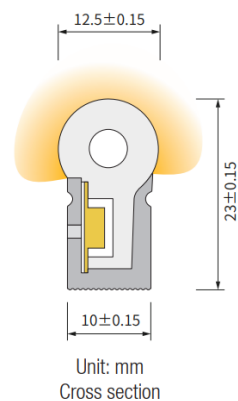
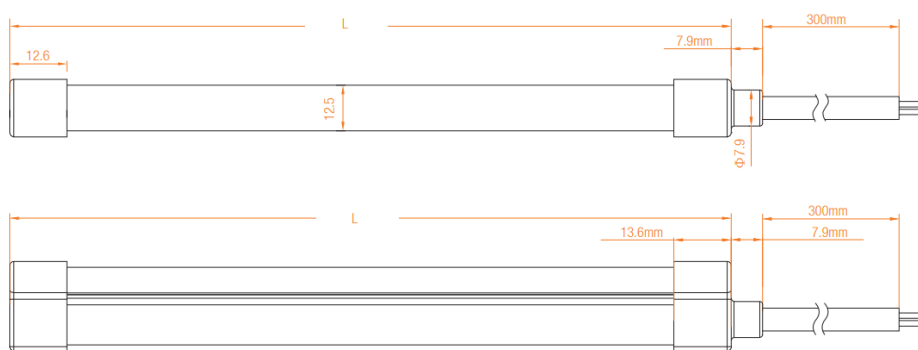

Connection Diagram

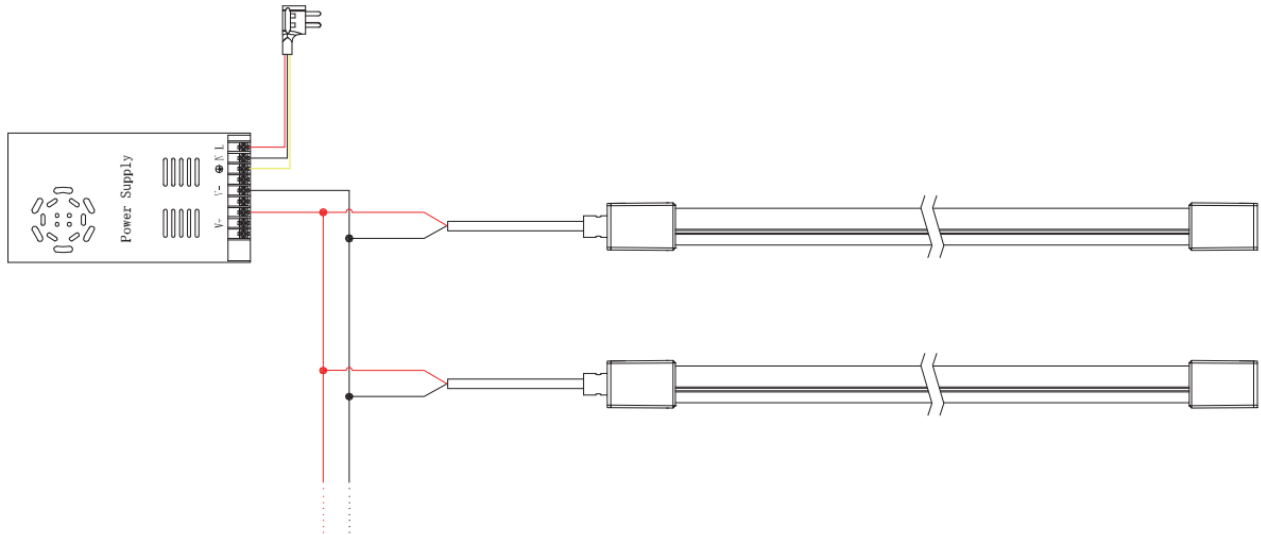

Single Color Connection Diagram

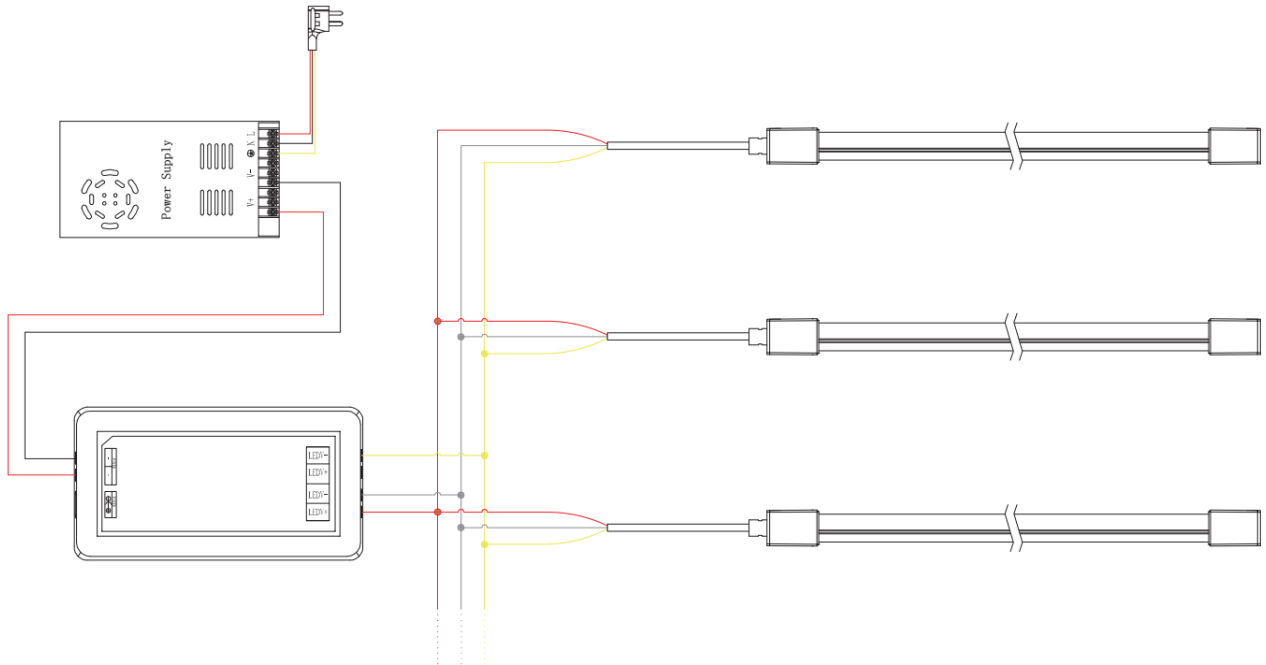

Tunable White Connection Diagram

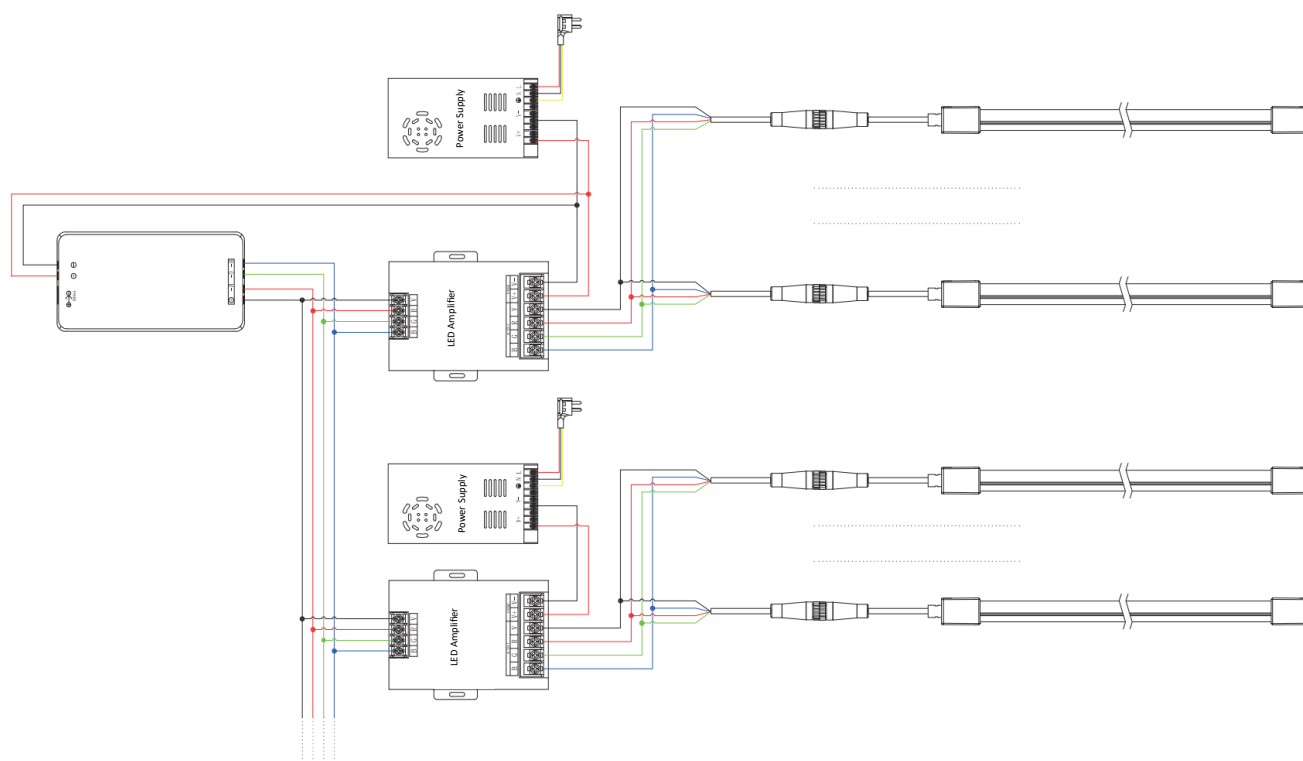

RGB Connection Diagram

PRODUCTTYPE	Dimension	POWER	LIGHT COLOR
EE -NL	1023	/ 15 -	24

10x23 mm

WATT/m

2400 KELVIN

SUMMARY PRODUCTCODES LED SELECONE NEON LIGHT 15WATT 10x23 mm

- EE-NL1023/15-21
- EE-NL1023/15-24
- EE-NL1023/15-27
- EE-NL1023/15-30
- EE-NL1023/15-35
- EE-NL1023/15-40
- EE-NL1023/15-50
- EE-NL1023/15-60
- EE-NL1023/15-TW
- EE-NL1023/15-R
- EE-NL1023/15-G
- EE-NL1023/15-B
- EE-NL1023/15-Y
- EE-NL1023/15-P
- EE-NL1023/15-RGB

Accessories CODES FOR LED SELECONE NEON LIGHT 10x23 mm

EE-NLCL/1023

EE-NLAP/1023 -1000

